



Product Catalogue

Professional Event Solutions

Maxibit – The Greener Choice

Maxibit is a leading innovator and manufacturer of environmentally friendly brand building and sales generating tools for event and exhibition solutions.

In 1978 Maxibit started on the core idea to pack pre-manufactured displays into lightweight, portable and totally reusable units. The displays were more environmentally friendly and better for marketing communication than the custom booths built on-site that was the standard at the time.

Today, Maxibit is an established leader in innovative, user centric display systems that is both light and mobile. With the innovative Maxibit stretch fabric systems, you can use the modular curves of Scene UltraLight or Stage Impact to seamlessly create various shapes without the need to reprint your graphic. With representation worldwide, Maxibit has grown to be one of the leading sales and brand building tools for premium brand companies worldwide.

Maxibit is a selected member of UN Global Compact and is leading the way for the portable industry. We have created a sustainable business by being at the forefront, thinking beyond profit, and striving for more social imperatives. The Environment is central to our business strategy.



Contents

Fabric Solutions

Scene UltraLight	4-5	Stage Hanging	11
Scene Modular	6-7	Stage Modular	12-13
Stage Impact	8-9	Stage Ellipse	14
Stage TradeFair	10	Stage Tension	15

PopUp Solutions

Network	16-17	Max	18-19
---------	-------	-----	-------

Banner Stands

Zap D1, D2 & D3	20-21	Solo 1 & 3	22-23
-----------------	-------	------------	-------

Counters & Podiums

LaunchPack	24	All-in-one Case	28
LaunchPack XL	25	Stage Table	29
CounterCase	26		
CounterCase XL	27		

Outdoor Solutions

BeachFlag	30-31	Branded tent	34-35
AirArch	32-33		

Accessories

Eagle Brochure Stand	36	Scene SmartHanger	38
iPad Stand	37	Stage Accessories	39

Scene UltraLight

The most compact backdrop ever seen



What is Scene UltraLight?

Scene UltraLight is an innovative fabric display that uses the latest in stretch fabric technology to give you a flexible display that can be transported easy. The unique hard case is designed for rough handling, holds a full 3 meter backdrop and you can transport it with you on the airplane. Setup in minutes, you will have a curved or straight backdrop that perfectly frames your event.

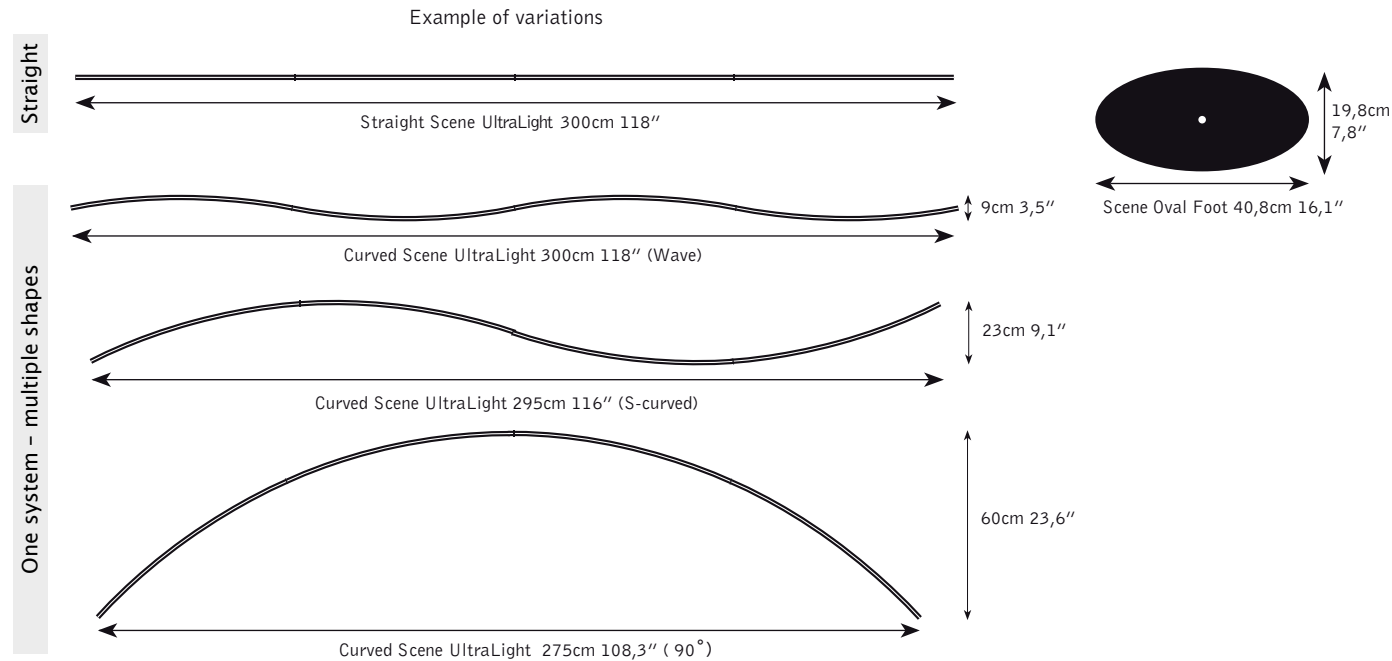

Why choose Scene UltraLight:

- **Lightweight and impressive size**
3 x 2,25 meters
- **Easy to transport and simple to setup**
- **One system - create 16 variations with the same hardware and graphic according to your needs**
- **Connect several units together with the magnetic connectors**
- **Environmentally friendly solution**
- made from 100 % recyclable parts

WIDTH:

Each variation is 300 cm

HEIGHT:

225 cm

WEIGHT:

10 kg including case and graphic



Scene Modular

A unique fabric experience tailored for you



What is Scene Modular?

Scene Modular is a fabric system with a selection of parts that enables you to customize your Scene experience. Scene Modular allows you to build straight fabric walls up to 3 meters tall at any width or create hanging banners from the ceiling.

Why choose Scene Modular:

- Customized to your unique requirements
- Build lightweight, flexible banners that are easy to transport
- Perfect for smaller public events, "step & repeat" and career days
- Create backdrops or banner stands
- Can be hung on a wall or ceiling and storefronts with Scene SmartHanger (see page 38)



WIDTH:

Customizable width starting at 50 cm and available in increments of 25 cm

HEIGHT:

Pole is extendable from 88-225 cm and with an extra pole build up to 300 cm

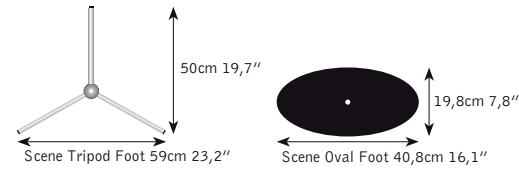

Standard

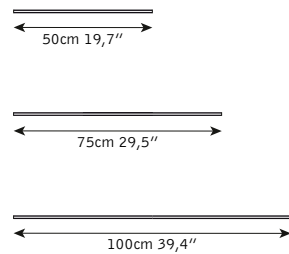

Example of variations

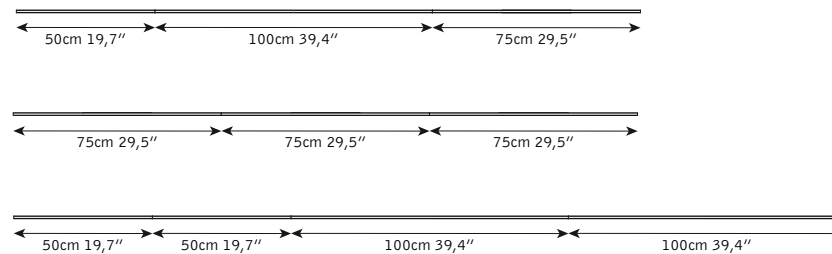

Stage Impact

Modular communication that stands out



What is Stage Impact?

Stage Impact is a tension fabric system that is easy to use and quick to set up. Stage Impact covers almost every presentation requirement from curved to s-shaped and straight walls as well as trade show displays in an endless variety of size options.

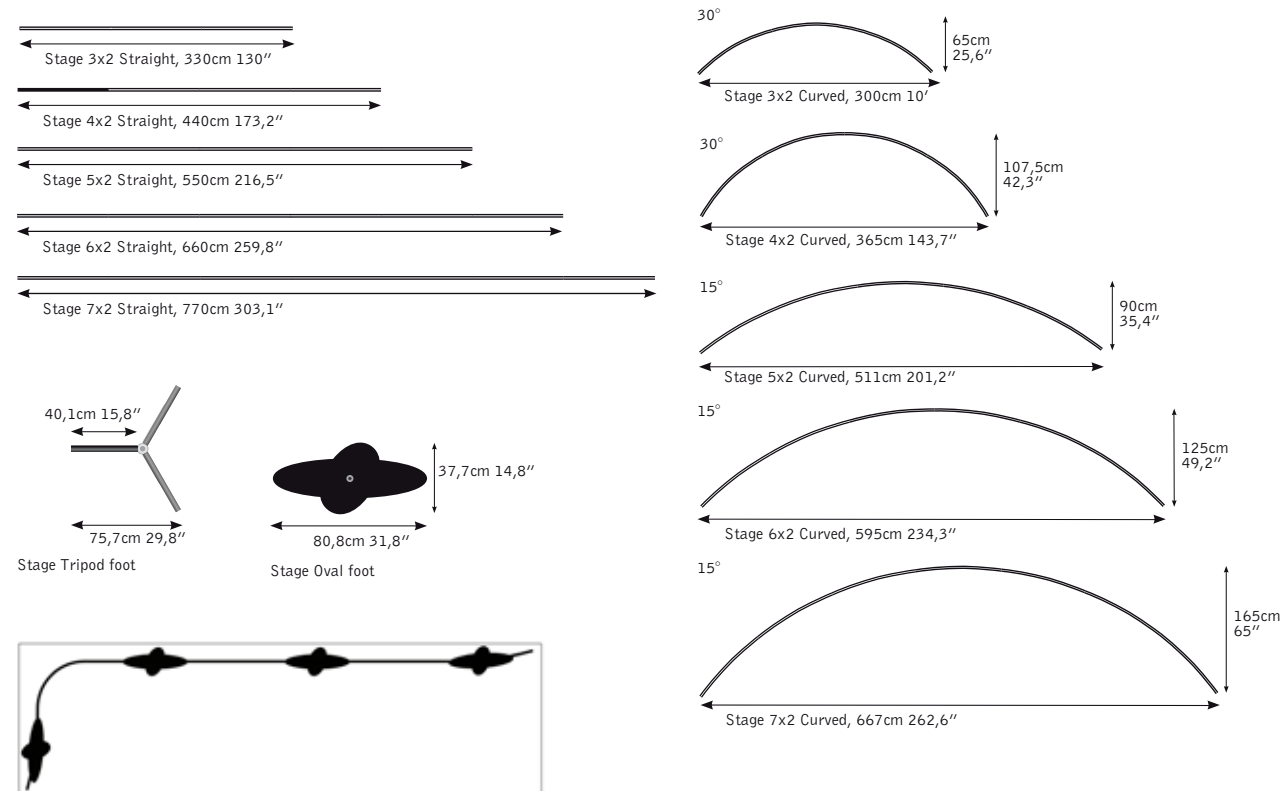

3572-TF Stage Trade Fair 7x2m 23'x6'5"

Why choose Stage Impact:

- Tension fabric displays are the future, get tomorrow's technology today
- Flexible solutions - custom appearance
- Stage is perfect for public spaces, conferences, company events and trade shows
- Stage is compact to transport and gives you a huge image area
- Environmentally friendly solution. The hardware is made from 100 % recyclable parts

WIDTH:

Variable depending on the configuration
 Straight from 330 cm
 Curved from 300 cm

HEIGHT:

110 - 330 cm

WEIGHT:

From 15 kg depending on configuration



Stage TradeFair

Simplistic super size fabric solutions



Why choose Stage TradeFair:

- Standard kits for corner booths
- Flexible solution - custom appearance
- Perfect for trade fair booths, public spaces, congresses, company events
- Compact to transport and gives you a huge marketing surface area

What is Stage TradeFair?

Stage TradeFair is a tension fabric system that is easy to use and quick to set up. The various Stage TradeFair kits covers a variety of standard L-shaped booth sizes. Despite its standardization it's still flexible; add a header when you have the ceiling height for it or combine it with your other Stage systems to form larger formations.

SIZE:

All kits are standardized for specific booth sizes; 4x2 m, 5x2 m, 6x2 m & 7x2 m. All kits are 225 cm high (244 with lamps). The Stage TradeFair kits can all be extended both higher and wider to serve your needs.

Examples of sizes; 4x2 m and 6x2 m

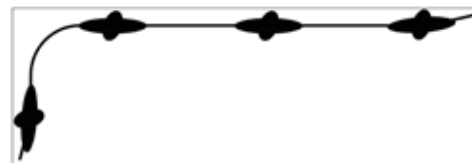
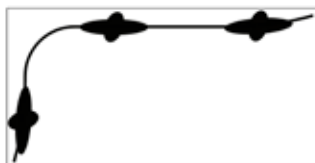

Stage Hanging

Customised communication for your next event



Examples of shapes & sizes

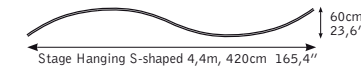
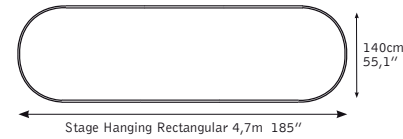
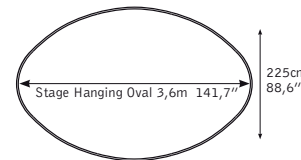
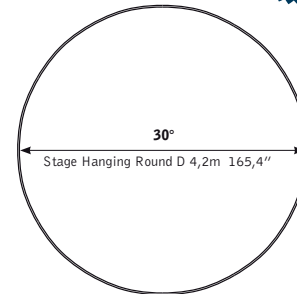

Why choose Stage Hanging:

- Ideal for large spaces such as convention halls
- Customised for your unique marketing requirements
- Creates high visual impact

What is Stage Hanging?

Stage Hanging is a selection of individual Stage parts that allows you to quickly assemble a hanging creation in any number of shapes, sizes and curves.

Heavy duty hangers allow you to safely hang it from the ceiling.

SIZE:

Standard and customizable size



Stage Modular

Customized communication for your next event

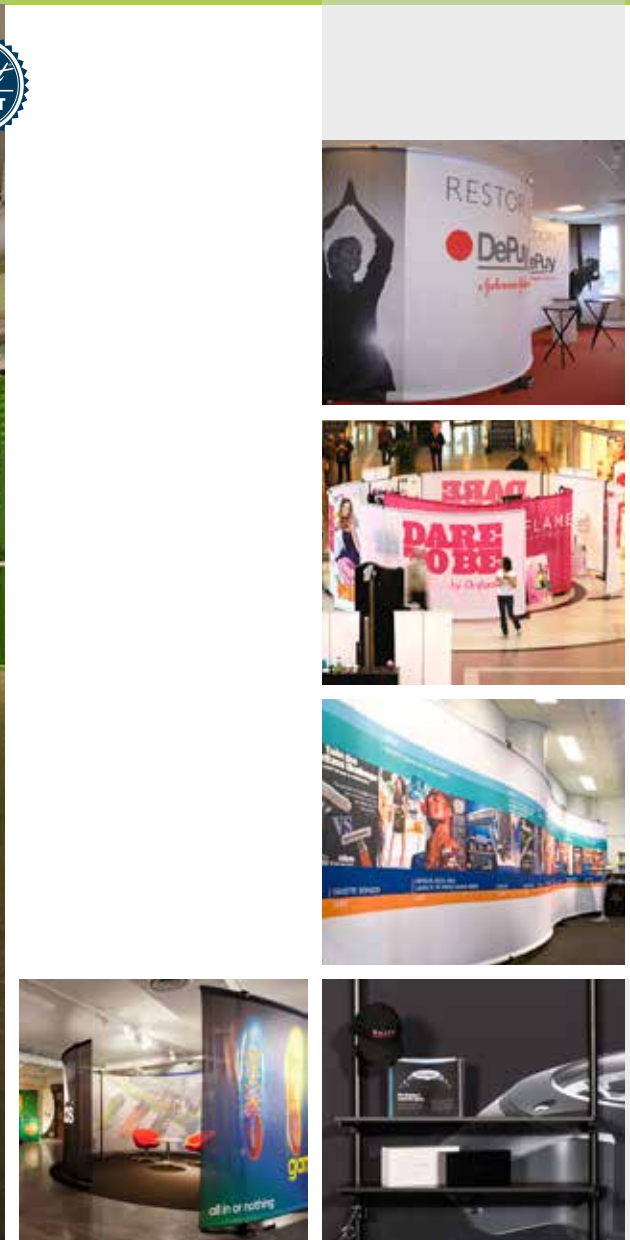

What is Stage Modular?

Stage Modular is the perfect solution to build large marketing surfaces with your own design. Stage Modular is a selection of individual parts that allows you to quickly assemble a Stage backdrop in any number of shapes, sizes and curves. With Stage Modular you can custom build in terms of height, width and various curvatures.

Examples of shapes & sizes

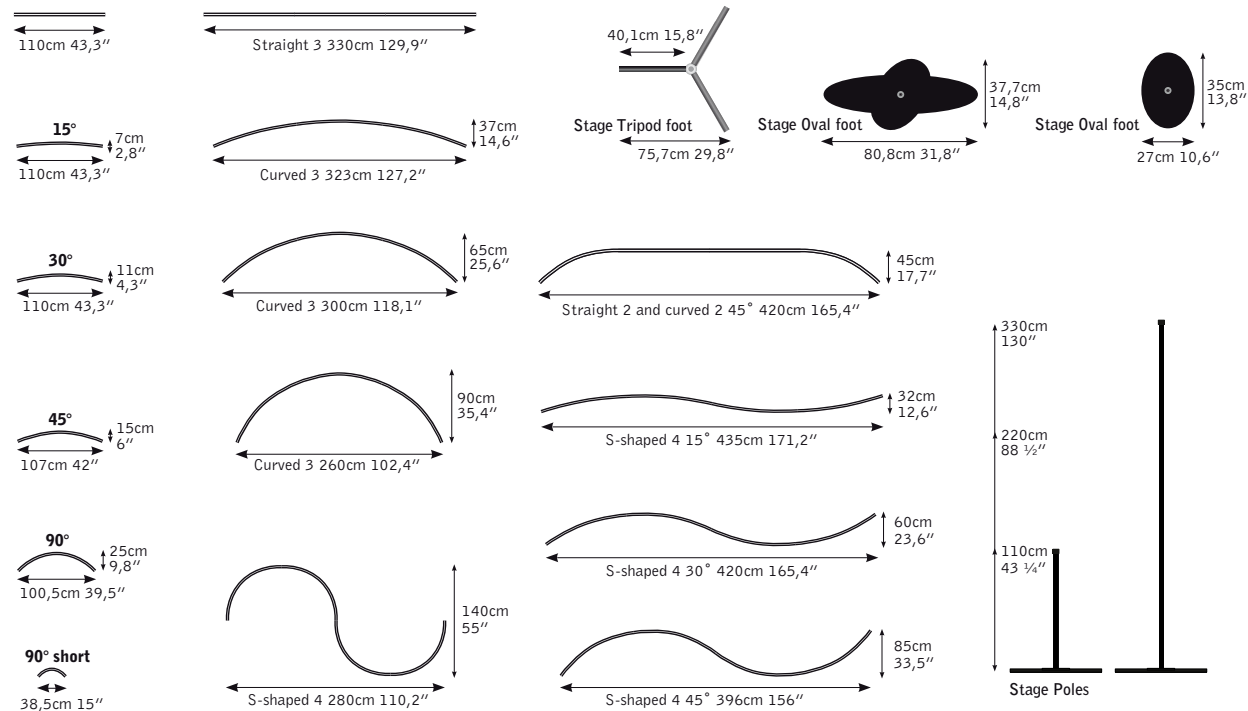

Why choose Stage Modular:

- Stage Modular is perfect when you need a creative custom solution
- Perfect for irregular spaces
- Ideal for large spaces such as stages, convention halls and shopping malls
- Perfect for creating your own marketing space tailored to your brand

WIDTH:

Customizable width. Starting at 110 cm and can be extended in increments of 110 cm

HEIGHT:

Customizable height. Starting at 110 cm and can be extended in increments of 110 cm



Stage Ellipse

Eye catching marketing. The first non-rectangular portable backdrop



Why choose Stage Ellipse:

- Unique eye catching shape
- Perfect for smaller events
- Fast and simple set-up
- Light weight and handy
- Double sided

What is Stage Ellipse?

Is a rectangular design the best choice if you want to stand out from the crowd? Maybe a creative custom shape would reflect your brand better. With Stage Ellipse you can get the custom eye catching impression with the simplicity of a standard portable large bannerstand or small backdrop. The size is equivalent to a pop-up or three rollups and is perfect for any small event. The complete unit, including graphics travels in a handy shoulder bag.

WIDTH: 300 cm **HEIGHT:** 225 cm

WEIGHT:

9 kg including graphic and shoulder bag



Stage Tension

Be square no more



Why choose Stage Tension:

- Fresh, playful and creative feeling to your brand
- Double sided – two shapes in one
- Can be used both as backdrop or bannerstand
- Can be used both as a single eye catcher or combined

What is Stage Tension?

Why limit yourself to 2D-marketing? Stage Tension forms a beautiful shape for your message. It's freestanding, double sided and marks the beginning of non-rectangular portable 3D-shapes. Use a single unit at the airport or shopping mall event. Or combine several units to form completely new backdrop shapes to your booth. And large as it is it still fits into the handy carrying case, even including graphics!

WIDTH: 1,85 m / **HEIGHT:** 2,5 m

DEPTH: 0,9 m

WEIGHT: 13,5 kg incl case and graphic

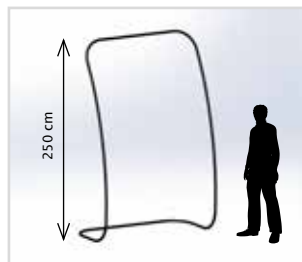

Network

A flexible pop-up system with unlimited layout options



What is Network?

Network is a pop-up backdrop system that is modular and can be designed in different shapes and up to 3,75 meters in height. With Network Frost you can turn the display system into a refined shelving system for a walk around experience of your displayed products.

Examples of shapes & sizes

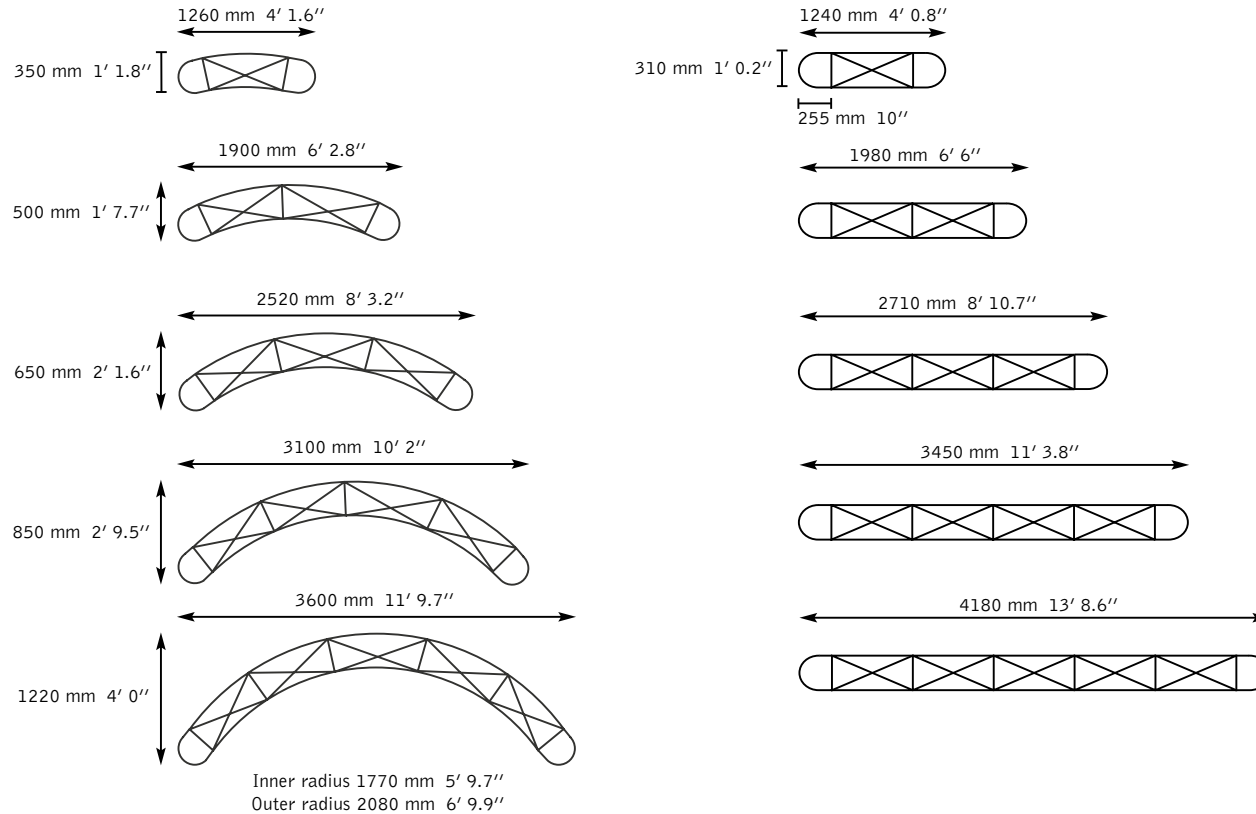

Why choose Network:

- Unlimited layout options
- Continuous seamless graphics
- Sturdy design with a professional look
- Adjustable feet for uneven floor
- Create showcases with Network Frost shelves
- Curved or straight end panels

WIDTH:

Straight: Customized width. Starting at 73 cm and can be extended in increments of 73 cm

Curved: Customized width. Starting at 68 cm and can be extended in increments of 68 cm

HEIGHT:

Customized height starting at 74,5 cm and can be extended in increments of 74,5 cm

WEIGHT:

4x3 section = 33 kg incl. graphics, lights and display counter



Max

A new popup system that is quick to set up, with easy graphic change



What is Max?

Max is a compact and versatile pop-up system that is quick to set up at any location. Max is available in straight, curved as well as double or single sided configurations to meet any space requirement.

Examples of shapes & sizes

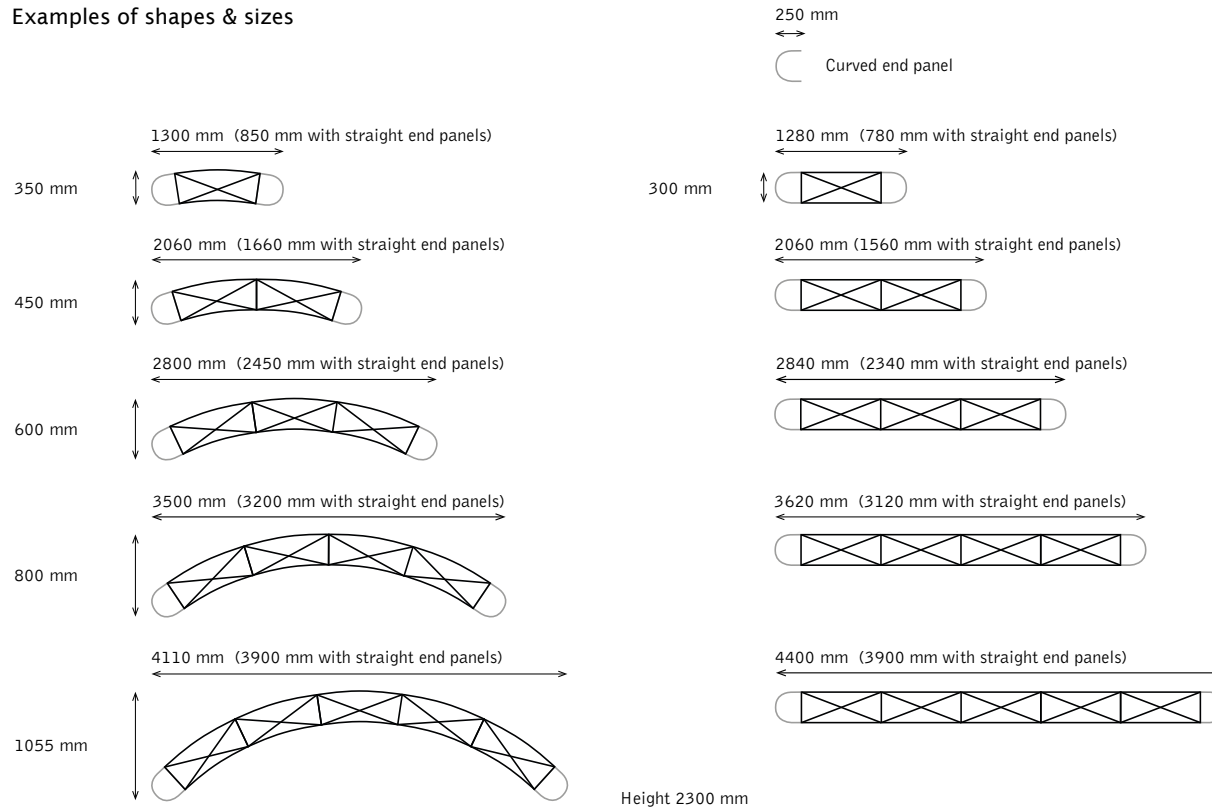

Why choose Max:

- Super fast set up
- Continuous seamless graphics
- Folding magnetic channel bars
- Clean design with a professional look
- Single or double sided
- Curved or straight end panels

WIDTH:

Curved: from 270 cm up to 337 cm
Straight: from 280 cm up to 355 cm

HEIGHT:

230 cm

WEIGHT:

3x3 section = 15 kg incl. graphic



Zap D1, D2 & D3

Maxibit's premier retractable solutions with a clean design



What is Zap D1, D2 & D3?

With Zap D1, D2 and D3 your message is delivered with strong impact and with the highest quality hardware and extremely easy graphic change. Zap comes in three designs. D1 is the most compact, D2 takes you to our exclusive range together with D3. D3 has no visible protruding foot on the floor. When it's time for your next campaign, you can change your message on-the-fly in less than a minute.

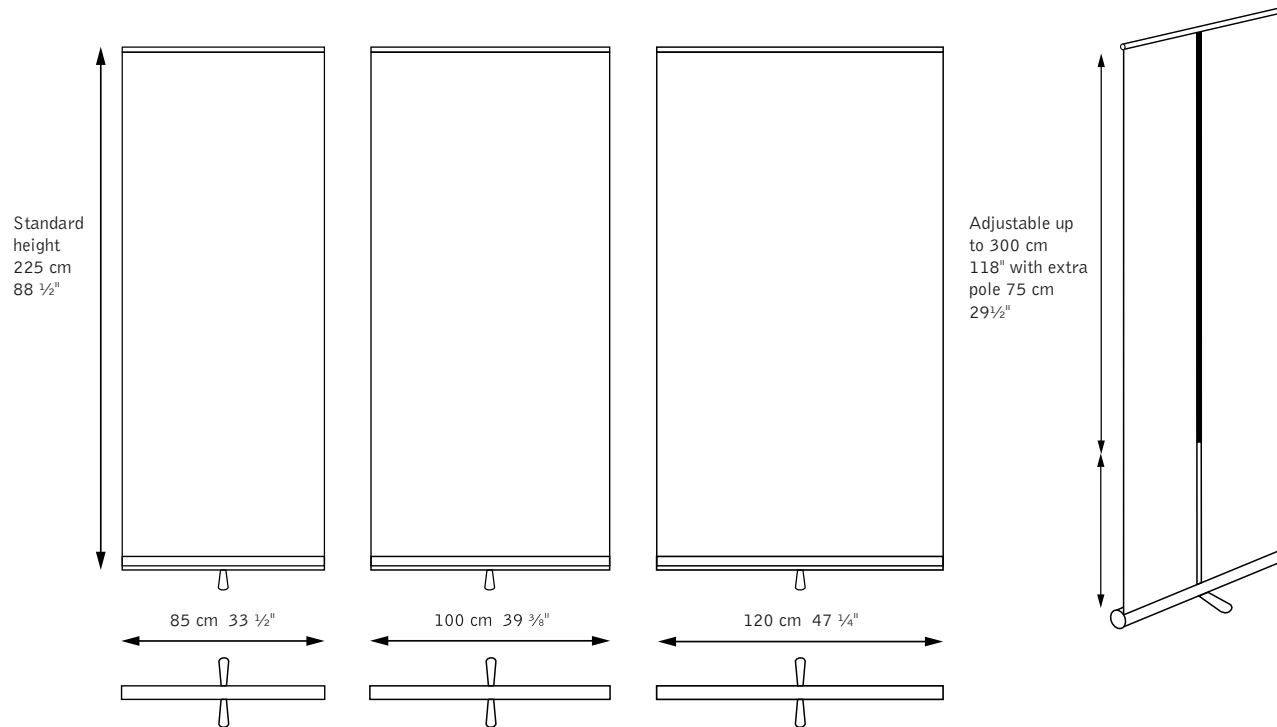

Why choose Zap D1, D2 & D3:

- **Unique Gripper profile**
- **Fast and easy graphics exchange**
- **Air damped chock absorption**
- **Three designs and three widths; six different versions to choose from**
- **Generous graphic dimensions**
- **Adjustable height**
- **No tools needed**
- **100% recyclable for a better environment**

WIDTH:

85 cm, 100 cm and 120 cm

HEIGHT:

Standard 225 cm (adjustable 90–300 cm)

WEIGHT:

Approx. 4 kg including graphics and carry bag



Solo 1 & 3

Light and mobile graphic stand with a clean design



What is Solo 1 & 3?

Solo is an ultra-compact banners stand solution. Solo 1 with a clean design and no visible foot on the floor and Solo 3 with an elegant, fold-out tripod foot. The telescopic pole and a bottom slider accommodate height adjustment to fit your preferences. Solo can be seamlessly connected side by side, straight or at an angle, thanks to the built-in power-magnets.

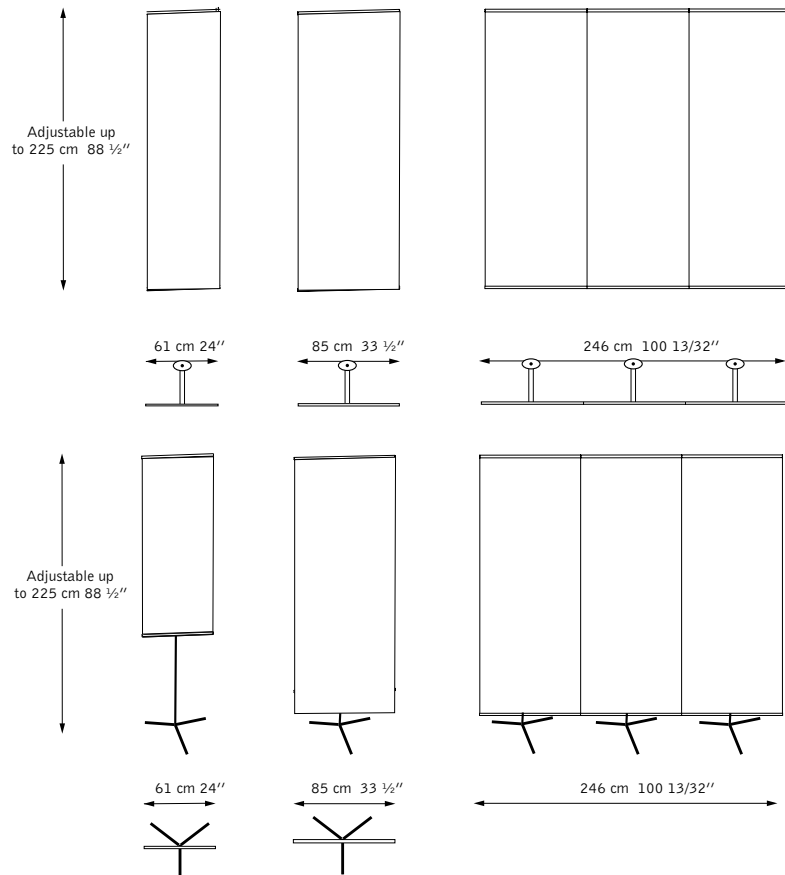

Why choose Solo 1 & 3:

- Ultra-compact for easy carrying and shipping
- Adjustable height
- Solo 3 is single or double sided
- Unique Gripper profiles for easy graphics exchange
- Create impressive larger backdrops by lining up multiple units side by side with the built-in power-magnets
- 100% recyclable for a better environment

WIDTH:

61 and 85 cm

HEIGHT:

Adjustable up to 225 cm

WEIGHT:

From 2,1 kg including graphics and carry bag

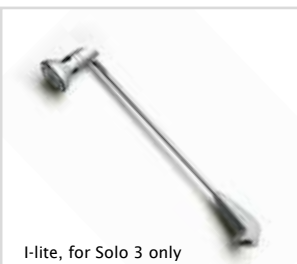

LaunchPack

Unique multi-purpose design



Why choose LaunchPack:

- All-in-one podium and transport case with built-in shelf
- Unique suite case design for easy transportation. It can be checked as luggage on the airplane
- Environmentally friendly product - made from 100% recycled plastic
- Perfect for transportation of Scene UltraLight or Solo

What is LaunchPack?

LaunchPack is the perfect podium for any occasion. Complete Point-of-Sales solution with options for multiple variations. LaunchPack is available with options such as SoundPack, CookPack and ShowPack.

SIZE (LxWxH)

Podium: 101x61x103 cm

Case: 101x61x27 cm

WEIGHT

14 kg



SoundPack top



ShowPack top



CookPack top



LaunchPack XL

Double the fun



Why choose LaunchPack XL:

- Extra large yet portable event counter
- Large interior shelves
- Easy access top compartments

What is LaunchPack XL?

LaunchPack XL is probably the largest portable event counter on the market – and it can pack a backdrop. LaunchPack XL has generous interior storage. The top shelves can be opened to reveal two extra, conveniently hidden, storage compartments. It's perfect for events, presentations, product demos and food and drinks sampling. It all transforms into two transport cases on wheels. Maxibit CounterPack XL is covered by patent. No tools needed.

SIZE

Footprint: 238 x 96 cm

Depth of top shelf: 66 cm

Cases (2x): 101 x 61 x 27 cm

WEIGHT

25 kg incl case and graphic



CounterCase

Folding suitcase counter



Why choose CounterCase:

- Small events in public spaces
- Information desk, check-in counter
- Product presentations
- Packs a popup or Scene backdrop
- Comes with four interior shelves

What is CounterCase?

The new CounterCase is a self-contained display counter integrated within a sturdy wheeled carry-case. Shelves, graphics wrap and counter top fit inside together with your choice of Maxibit backdrop display. For example Max pop-up, Network pop-up, Scene UltraLight, etc

SIZE

Footprint: 125 x 65 cm

Depth of top shelf: 34 cm

Case: 41 x 64 x 96 cm

WEIGHT

Case 10 kg, Top 5,5 kg



CounterCase XL

Large reception counter on wheels



Why choose CounterCase XL:

- Large embracing counter
- Information desk, check-in counter
- Product presentations
- Packs two popups or Scene backdrops
- Comes with 4 x 2 interior shelves

What is CounterCase XL?

The new CounterCase XL is two CounterCases side by side with a large folding top. It's a self-contained display counter integrated within a sturdy wheeled carry-case. Shelves, graphics wrap and counter top fit inside together with your choice of Maxibit backdrop display. For example Max pop-up, Network pop-up, Scene UltraLight, etc.

SIZE

Footprint: 220 x 90 cm

Depth of top shelf: 34 cm

Cases x2: 41 x 64 x 96 cm

WEIGHT x2

Case 10 kg, Top 5,5 kg



x2



All-in-One Case

Turn your transportation box into an effective marketing tool



Why choose All-in-One:

- Built-in wheels and carry handle for easy handling
- Wooden folding top in black with exclusive hinges
- Graphic display area to display your logo
- All-in-One is perfect for transportation of pop-ups, banner stands and Scene UltraLight

What is All-in-One?

The All-in-One Case is a durable transportation box that easily can be turned into a counter with a wooden top and a graphic wrap on the outside. Use a single All-in-One Case for small space settings or a double All-in-One for larger surface needs.

SIZE (LxWxH)

Podium: 100x74x49 cm

Double Podium: 100x156x56 cm

Case: 99x59x43 cm



Stage Table

Light and easy to set up and gather around



Why choose Stage Table:

- Intuitive and easy set up
- Large base for maximum stability
- Completely collapsible and portable
- Delivered in two nylon carry bags

What is Stage Table?

The Stage Table is a modern version of a bar height cafe table that is collapsible, light to carry and easy to set up. The table is a perfect meeting point at any event. Use a single table or in a group, together with a backdrop wall or on its own.

HEIGHT:
98,5 cm

WEIGHT:
4,5 kg



BeachFlag

Marketing in a breeze



What is BeachFlag?

Maxibit's BeachFlags are the ideal advertising solution when it comes to outdoor events. Setting up the Beach Flag is easy thanks to our range of custom bases for snow, beach, grass or concrete. The flag is available in two different models in several sizes, to ensure the best solution for displaying your company logo or message.

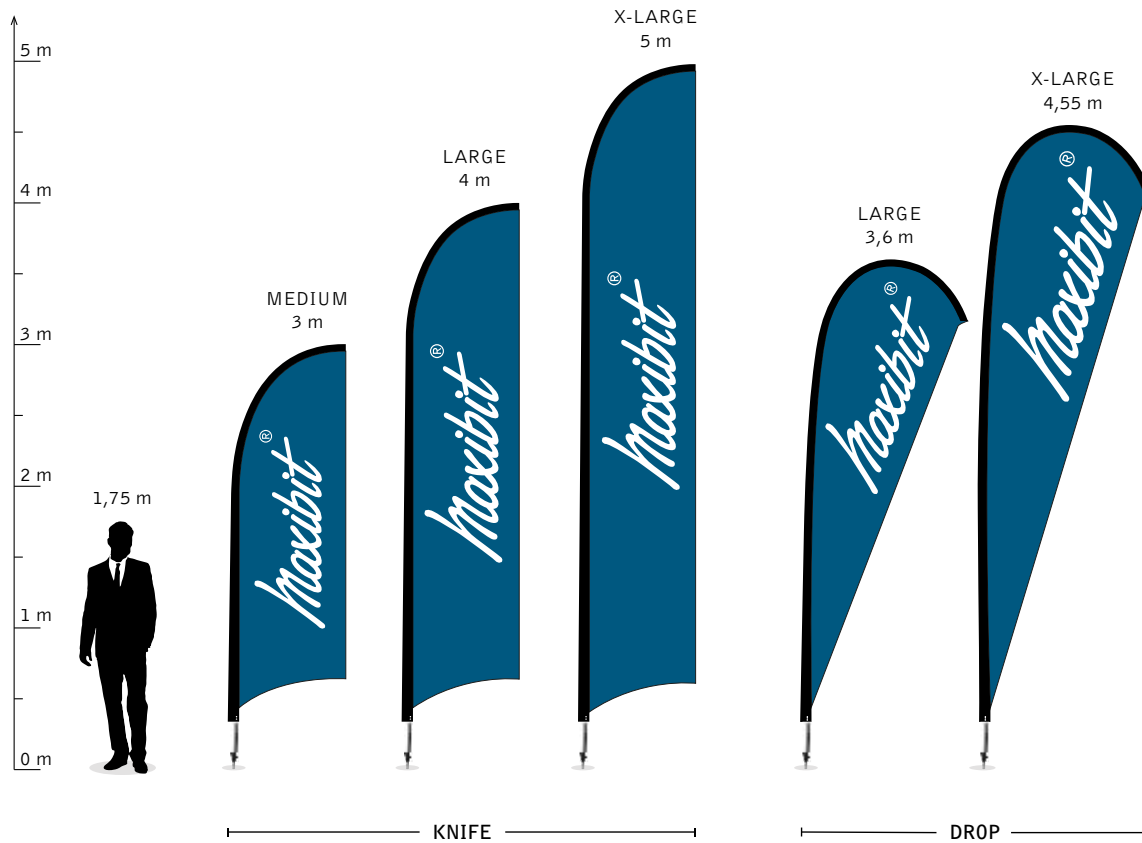

Why choose BeachFlag:

- Creates high visual impact
- Easy to transport and set up in any desired environment
- The rounded corner designs ensures that the fabric is stretched tight and the pole stays straight, even in windy conditions
- All BeachFlags come complete with a carry bag
- 100% recyclable material for a better environment

HEIGHT:

Knife: three different heights; 300 cm, 400 cm and 500 cm

Drop: two different heights; 360 cm and 455 cm

WEIGHT:

The weights range from 1,8 kg to 4,5 kg including the flag and carry bag



AirArch

Framing your event



What is AirArch?

Maxibit's inflatable AirArches are perfect tools used at athletic events such as marathon, triathlon, race to identify start, finish or transition points or at any outdoor event and as an exhibition stand. They are giving a lot of attention and are therefore optimal for marketing and branding. Both of our inflatable arches are portable made for easy setup including the electrical pump.

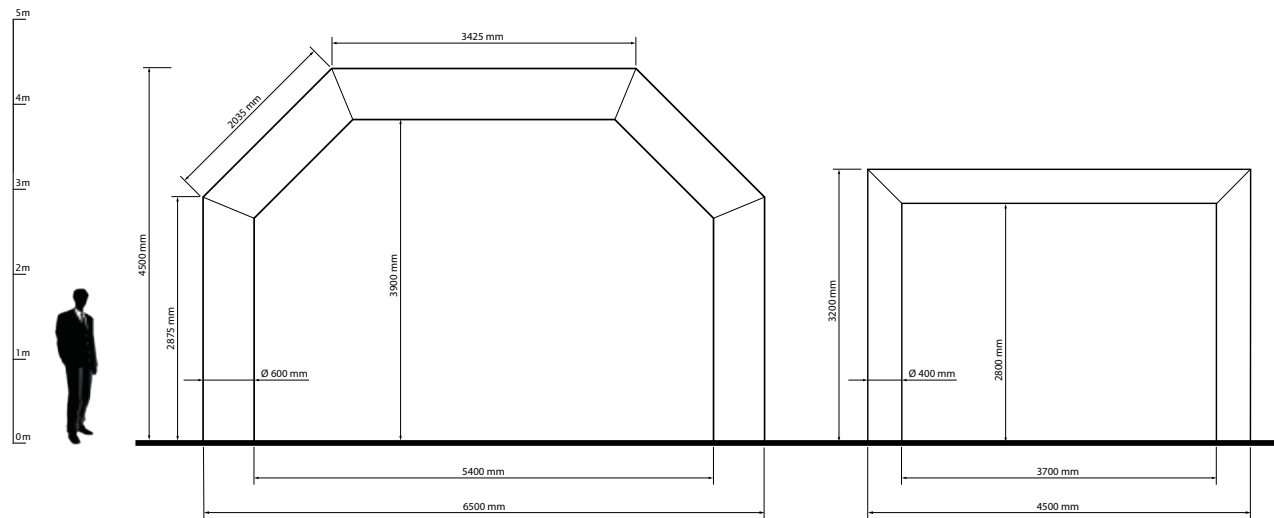

Why choose AirArch:

- Creates high visual impact
- Easy setup, electrical pump included
- Easy to store
- Lightweight and easy to carry
- Sealed air inflatable arch, no need for continuous electrical power. Once inflated the blower can be switched off and the arch will stand for days
- Safer, it does not come down all at once if there are people under the arch

HEIGHT:

Large arch: Outer: 450 cm Inner: 390 cm

Small arch: Outer: 320 cm Inner: 280 cm

WIDTH:

Large arch: Outer: 650 cm Inner: 530 cm

Small arch: Outer: 450 cm Inner: 370 cm

WEIGHT:

Large arch: 21 kg incl. pump

Small arch: 14 kg incl. pump



Branded tent

Claim your space



What is Branded tent?

Maxibit's Branded Pop-up tents are perfect at all types of outdoor events such as street fairs, flea markets and sport events. It will give shade help protect your products from the weather, define your space and maybe most important it's a chance to advertise your brand. Our tents are available in standard white and a great way to draw attention is to have it printed to showcase your brand.

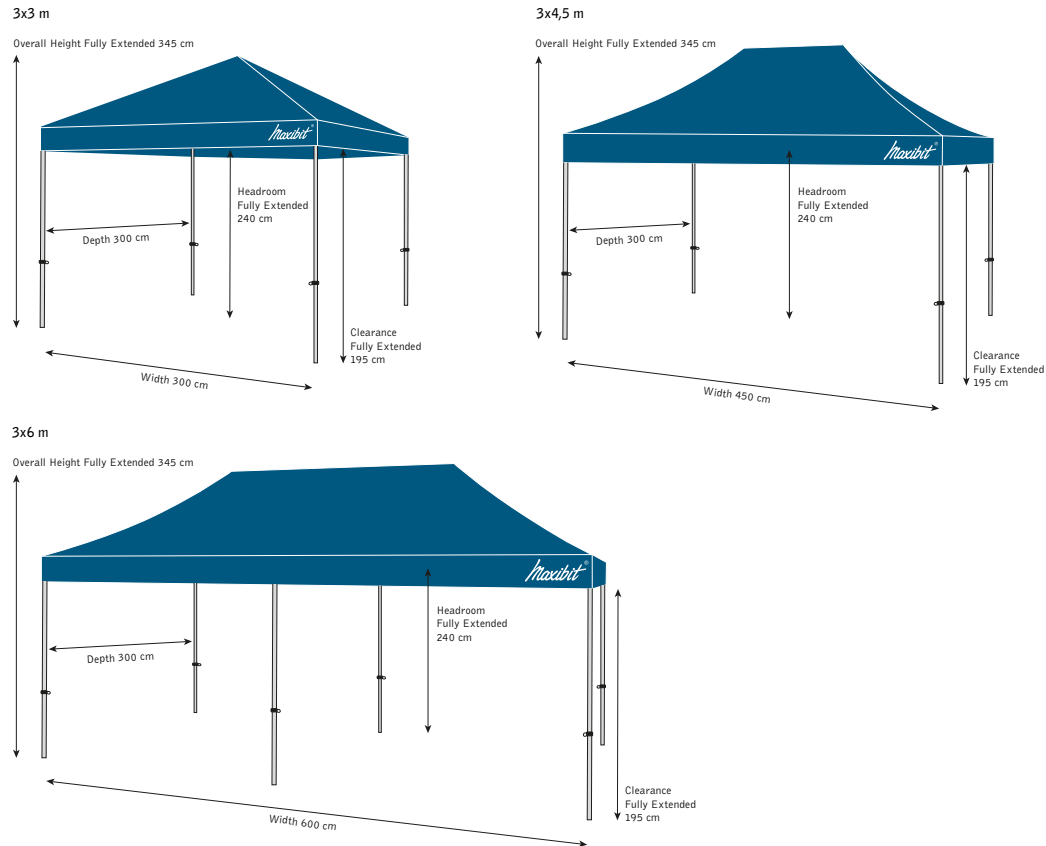

Why choose Branded tent:

- Creates high visual impact
- Define your space
- It gives shade and shelter, protects you and your products from the elements
- Helps you be more accessible going where the customers are

SIZE	WIDTH	DEPTH	HEIGHT
3x3 m	300 cm	300 cm	345 cm
3x4.5 m	450 cm	300 cm	345 cm
3x6 m	600 cm	300 cm	345 cm

WEIGHT	Frame+roof	3 walls	4 walls
3x3 m	22.9 kg	5.2 kg	6.9 kg
3x4.5 m	30.3 kg	7.5 kg	10 kg
3x6 m	39.7 kg	9.5 kg	12.8 kg



Eagle Brochure Stand

A brochure stand that is both simple and effective



Why choose Eagle:

- Quick to set up with auto-locking mechanism
- Comes in two different colors, black and light grey
- Brochures can be transported safely in the stand
- Delivered in a handy nylon carrying bag

What is Eagle?

Eagle is the ultimate brochure stand for displaying your marketing material. It is easy to use and unfolds in seconds. Its clear plastic pockets allow the transportation of brochures with the actual stand.

SIZE STANDING (WxDXH):

27x24,5x156 cm

SIZE PACKED DOWN (WxDXH):

27x24,5x40 cm

WEIGHT:

4,2 kg



iPad Stand

Lightweight lockable stand for your iPad tablet



Why choose iPad Stand:

- Quick to set up and easy to carry
- Works in any indoor environment
- Rotates 360° for portrait or landscape orientation
- Lockable holder to secure your iPad tablet
- Compatible with Maxibit Stage

What is iPad Stand?

The iPad Stand is a versatile and functional stand that can be used with iPad 2, iPad 3 and iPad 4. The angle can be adjusted and the iPad can be displayed in both landscape and portrait orientation. The sturdy tripod foot ensures stability.

WIDTH:

Foot: 49,5 cm

HEIGHT:

117 cm

WEIGHT:

2 kg



Scene SmartHanger

A unique fabric experience tailored for you



Why choose SmartHanger:

- Locks by gravity
- Re-usable, exchangeable graphics
- Intuitive, fool proof design
- 100% recyclable plastic

What are SmartHanger?

Scene SmartHanger is the latest little invention to meet your signage needs. No tools are needed, it can be used over and over again and your graphics are changed in seconds. It's a joyful little design that puts a smile on your face when you realize how smart and simple it is to use. It feels almost magnetic, or magical if you wish, but in reality it uses gravity in its favor. The heavier the pull - the harder the grip.

It's perfect for any situation where you want to hang a sign and preferably when the sign needs to be exchanged over and over again.

SIZE:

Fits 22 mm Scene tubes

Inner diameter: 22 mm

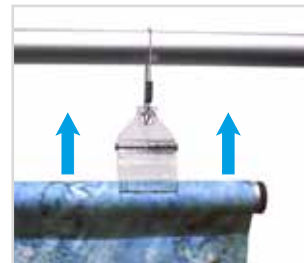

Stage Accessories

Hangers & shelves



Why choose Stage Accessories:

- Creates high visual impact, showing off your products
- Easy to transport and set up
- Use the existing poles for your Stage backdrop to hold the accessories, less hardware to transport

What are Stage Accessories?

The Stage Accessories are practical add-ons for Stage. It is an easy and portable way for you to show your products in a smart and compact way together with your Stage stand.

The Accessories can be used together with a backdrop wall, or stand alone with Stage vertical poles inside your booth, perhaps with shelves on two sides.

SIZE:

Shelf, black: 95x30 cm

Garment hanger inclined, silver: 30 cm

Garment hanger silver: 25 cm

Shelf bracket, silver: 25 cm



Maxibit worldwide



Maxibit/Screenbolaget AB

Visit: Elektravägen 18
P.O Box 42212, 126 17 Stockholm, Sweden
Phone: +46 8 781 04 50
E-mail: info@maxibit.com
www.maxibit.com

